



44 Crawley 4,4x3 S25642



Thickness:	Project name:	Project ID:	Year:	Page:
44	Crawley 4,4x3	S25642	2021	2

Floor bearers

1:40

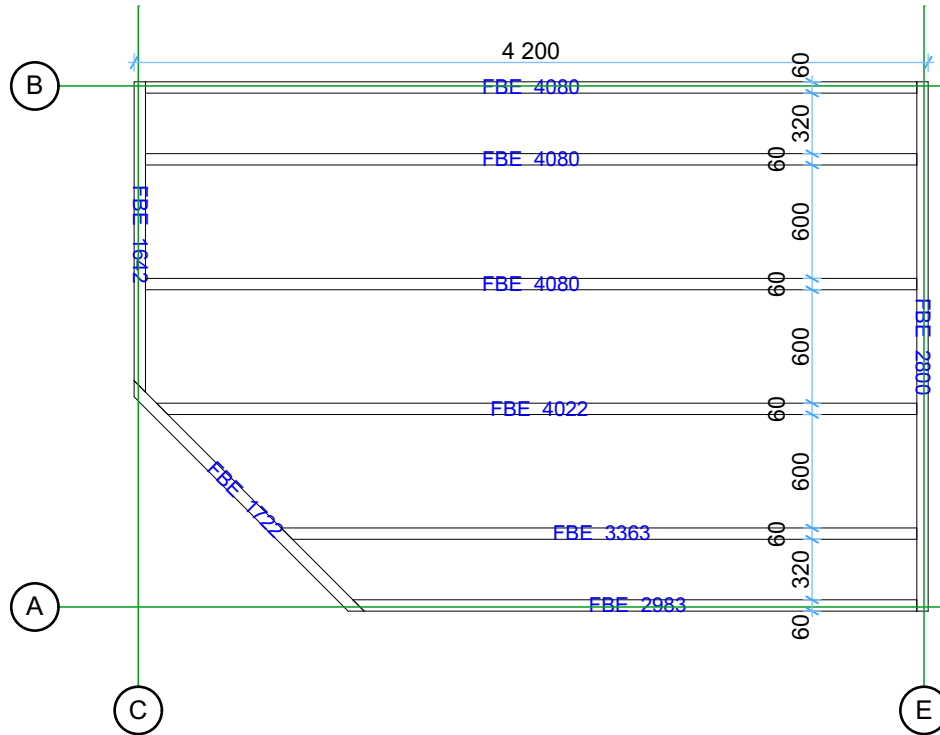

Ground floor plan

1:40

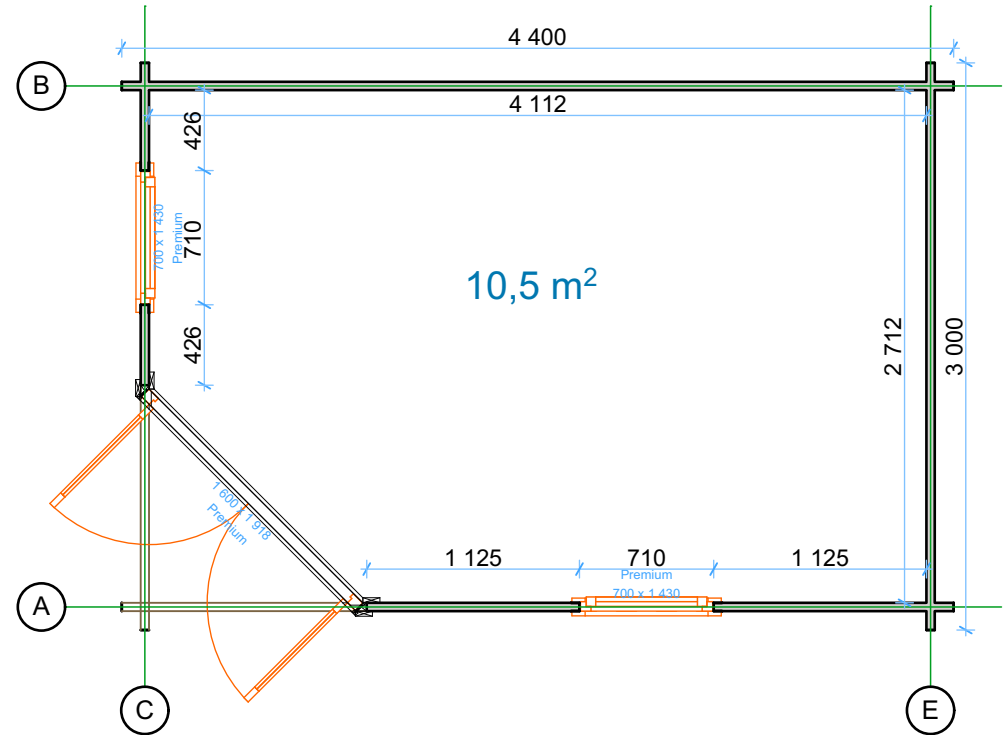

Thickness:	Project name:	Project ID:	Year:	Page:
44	Crawley 4,4x3	S25642	2021	3

Front Elevation

1:50

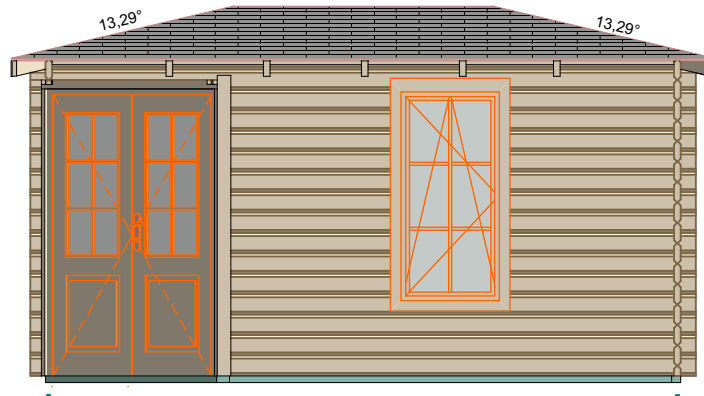

Left Elevation

1:50

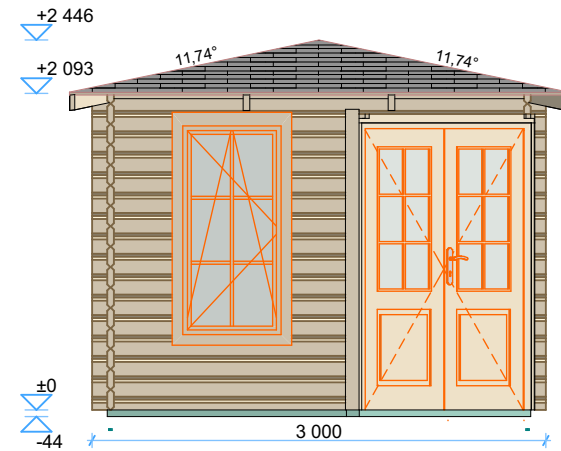

Back Elevation

1:50

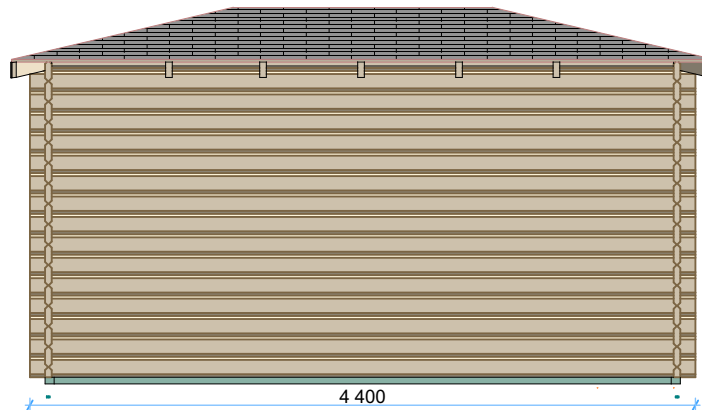

Right Elevation

1:50

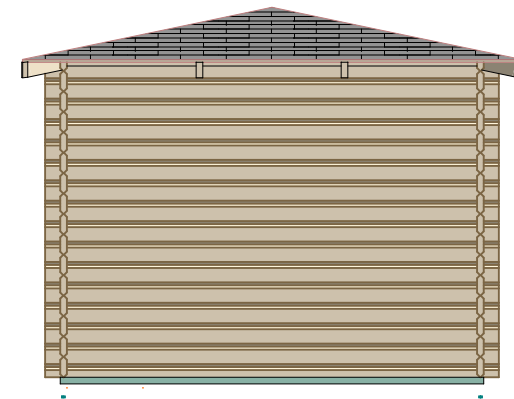

Thickness:	Project name:	Project ID:	Year:	Page:
44	Crawley 4,4x3	S25642	2021	4

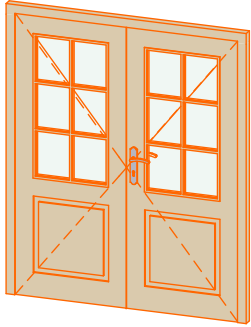
Windows and doors list					
Type-quality	W x H Size	Orientation	Glazing	Quantity	3D Axonometry
Door - Premium	1 600×1 918	R	50% glass, double glazed, Safety (toughened) glass	1	
Window - Premium	700×1 430	R	Double glazed, Safety (toughened) glass	2	